

MCA9 
Control Carbon
Potentiometers MCA

MCE9 
Control Cermet
Potentiometers MCE



CARBON – MCA9

9mm carbon potentiometers with plastic enclosure and shaft.

Through-hole and SMD configurations are available. Terminals and collector are normally manufactured in tinned brass, although versions with steel terminals are also available under request. Terminals for through-hole models can be provided straight or crimped, which helps hold the component to the PCB during soldering.

Ingress Protection rating type IP 54 (high level of protection against dust and also against water splashing), according to IEC 60529. Plastic materials can be self-extinguishable according to UL 94 V-0 under request.

Tapers can be linear, log and antilog; special tapers can also be studied.

Potentiometers can be manufactured in a wide range of possibilities regarding:

- Resistance value.
- Tolerance.
- Tapers / variation laws.
- Pitch.
- Positioning of the wiper (standard is at 50% rotation).
- Housing and rotor color.
- Mechanical life.
- Click effect (up to 20 detents available).
- Self-extinguishable plastic parts, according to UL 94 V-0.

Applications

9mm potentiometers are mainly used in control applications, in different markets:

- Industrial: Timers and relays, dimmers, adjustment of output.
- Electronic appliances: volume regulation, temperature controls and function selection.
- Automotive: Lighting regulation (position adjustment and sensing for headlights), dimmers, seat heating controls.

CERMET – MCE9

9mm cermet potentiometers with plastic enclosure and shaft. Cermet potentiometers have better thermal stability, allow for higher thermal dissipation and withstand higher temperatures than carbon potentiometers.

Through-hole and SMD configurations are available. Terminals and collector are manufactured in tinned brass, although versions with steel terminals are also available under request. Terminals for through-hole models can be provided straight or crimped, which helps hold the component to the PCB during soldering.

Ingress Protection rating type IP 54 (high level of protection against dust and also against water splashing), according to IEC 60529. Plastic materials (housing and rotor) are self-extinguishable according to UL 94 V-0 for ACP's cermet potentiometers.

Tapers can be linear, log and antilog; special tapers can also be studied.

Potentiometers can be manufactured in a wide range of possibilities regarding:

- Resistance value.
- Tolerance.
- Tapers / variation laws.
- Pitch.
- Positioning of the wiper (the standard is at 50%).
- Housing and rotor color.
- Mechanical life.
- Click effect (up to 20 detents available).

Applications

9mm cermet potentiometers are used in applications where either the operating temperature is high or where the application requires product with excellent ohmic value stability:

- Electronic appliances: temperature controls.
- Automotive: climate controls, position sensors, seat heating controls.
- Industrial electronics: multimeters, oscilloscopes, time relays, measurement and test equipment.

MCA9 MCE9 HOW TO ORDER

EXAMPLE: **MCA9DH5-10KA2020 SNP PI WT-9020-NE**

EXAMPLE: **MCE9DH5-10KA2020 SNP PI WT-9020-NE-V0**

Standard features								Extra features							Assembled accessory			
Series	Rotor	Model	Packg.	Ohm value	Taper	Tol.	Life	Track	Detents	Snap in	Housing	Rotor	Wiper	Lin.	Assembly	Ref #	Color	Flam.
1	2	3	4	5	6	7	8	9	10	11	12	13	14	15	16			
MCA9/MCE9	D	H5		- 10K	A	2020				SNP			PI		WT	-9020	-NE	-V0

Standard configuration:	MCA9 Through-hole	MCE9 Through-hole
Dimensions:	9mm	
Protection:	IP 54 (dust-proof) On request: Self-extinguishable, to meet UL 94 V-0	
Substrate:	Carbon technology	Cermet
Color:	Blue housing + white rotor	Brown housing + white rotor
Packaging:	Bulk	
Wiper position:	at 50% ±15°	
Terminals:	Straight, without crimping.	
Marking:	Resistive value marked on housing. Others on request.	

Customized products: A drawing is requested when ordering a customized product. Series, rotor, model and total resistive value are indicated before the code that includes all special specifications. Example: MCA9DH2,5-10K CODE C00111.

1 - Series

■ MCA9 ■ MCE9

2 - Rotors

D

3 - Model and pitch

H2,5 H3,8 H5 V7,5 V10 VK10 VR10

4 - Packaging

Trough-hole

Bulk (blank)

5 - Resistance value

100Ω 200Ω 220Ω 250Ω 470Ω 500Ω 1KΩ 2KΩ ... 500KΩ 1MΩ 2MΩ 2M2 4M7Ω 5MΩ
100 200 220 250 470 500 1K 2K 500K 1M 2M 2M2 4M7 5M

6 - Resistance law / taper

Lin - Linear A
Log - Logarithmic B
Antilog - Antilogarithmic C
- Special tapers have codes assigned: CODE YXXXXX

7 - Tolerance

±20% ±30% +50%,-30% ±10% ±5%
2020 3030 5030 1010 0505

8 - Operating Life (Cycles)

Standard (1.000 cycles) (leave blank)
Long life: LV + the number of cycles. ex: LV45 for 45.000 cycles. (others on request) LVXX: ex: LV45

9 - Cut Track – Open circuit.

Open circuit at beginning of track, fully CCW PCI
Open circuit at end of track, fully CW PCF

10 - Detents (DT)

One detent at the beginning DTI
One detent at the end DTF
X number of detents, evenly distributed. XDT: 10DT

Special detents are available on request: If you also need to assign a voltage value to each detent, please inquire.

11 - Terminals

SNAP IN P SNP
SNAP IN J SNJ
Shorter tip of terminal, TPXX, where XX is tip length (under request) TPXX, ex: TP25
Steel Terminals SH

12 - Housing

Color: For colors other than standard: -See color chart below- CJ-color, ex., red: CJ-RO

13 - Rotor

Color: For colors other than standard: -See color chart below- RT-color; ex., blue: RT-AZ

*** Self-extinguishable property, V0, for housing and rotor:** (blank)
By default, carbon is non self-extinguishable, cermet is Self-extinguishable: V0
For carbon: self-extinguishable property can be added. V0 means housing CJ-V0, RT-V0
and rotor are V0. If only the housing needs to be V0, then CJ-V0.
If only rotor: RT-V0

14 - Wiper

Wiper position (Standard: 50% ± 15°) (leave blank)
Initial or CCW PI
Final or CW PF
Others: following clock positions; at 3 hours: P3H PXH, ex: P3H
Wiper torque (Standard: <2.5Ncm, for detents: <3.5) (leave blank)
Low torque, < 1.5Ncm PGB

15 - Linearity

Not controlled (leave blank)
Independent linearity controlled & below x%, for example, 3%: LN3% LNx%; ex: LN3%
Absolute linearity controlled & below x% LAX%

16 - Potentiometers with assembled accessories

Assembled from terminal side WT-
Accessory Reference (9019 or 9020) -XXXXX, Example: 9019
Color of shaft -YY Example, black: NE
Non self-extinguishable. (leave blank)
Self-extinguishable according to standard UL 94 -V0
(-V0 in box 17 modifies only the accessory, please, note.)

Color chart for rotor, housing and accessories

Black ⁽¹⁾	White	Neutral	Transp.	Red	Green	Yellow	Blue	Grey	Brown
NE	BA	IN	TA	RO	VE	AM	AZ	GS	MR

(1) black is not an option for housings.

Models

All models shown here have shaft 9020, but other shafts can be chosen from the list below (Page 71). The D dimension indicated on the drawings refers to the possible length of the shaft, to be chosen at "shafts" section. Potentiometers are sold separately from the nuts and washers.

H2,5

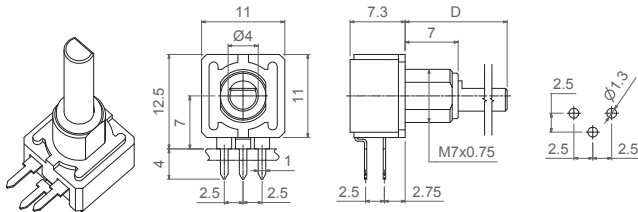

H3,8

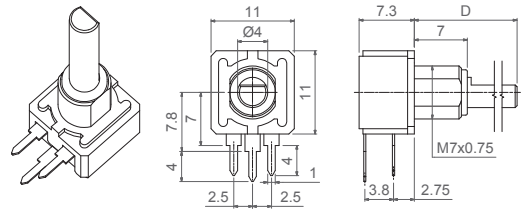

H5

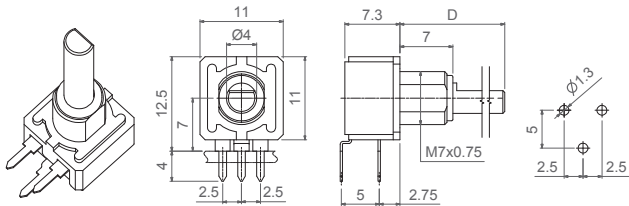

V7,5

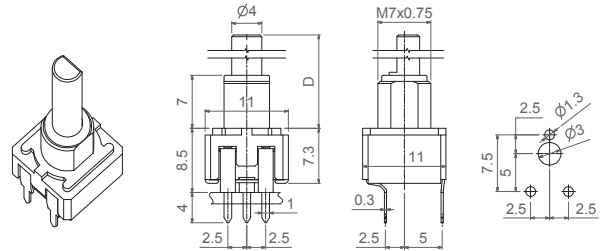

V10

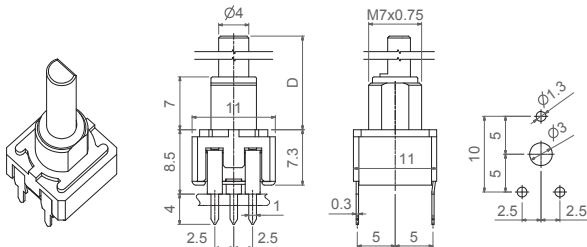

VK10

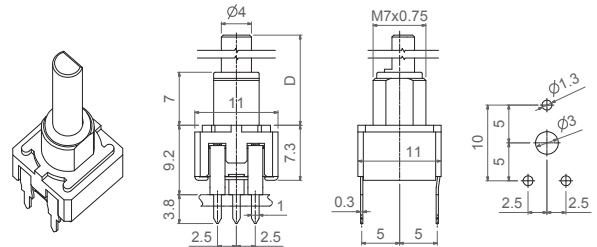

VR10

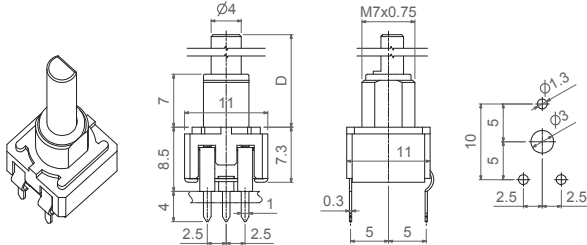

Nut

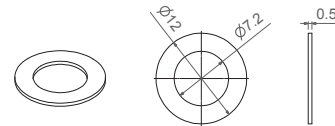

Washer

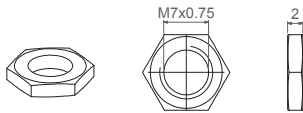

Nut and washer assembly indication

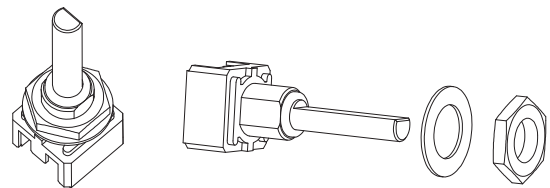

Tapers

The standard taper is linear (A). Log (B) and Antilog (C) tapers are also available, as well as special tapers according to customer's specifications. For example, a special taper can be matched with a potentiometer with detents (click effect), to guarantee a value in a specific position – see "detents" section.-

REGULAR TAPERS

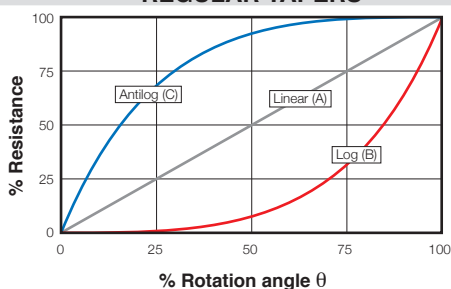

SPECIAL TAPERS

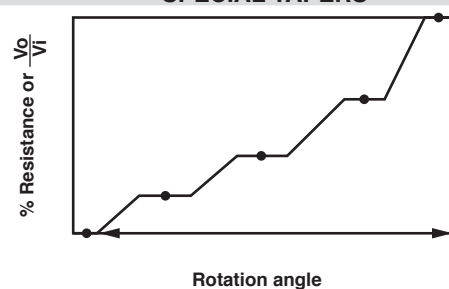

Potentiometers with cut track

The cut track is an area with very high resistive value, resulting in an open circuit. It is widely used in lighting applications.

Mechanical life with cut track needs to be confirmed.

PCI = Cut at initial position, when the potentiometer is turned fully counter clockwise.

PCF = Cut at final position, when the potentiometer is turned fully clockwise.

Other positions are available on request.

PCI

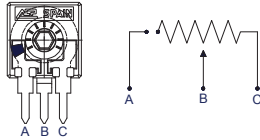

PCF

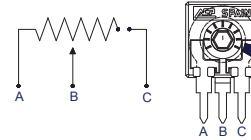

Potentiometers with detents

ACP's patented detent (DT) feature is especially suitable for control applications where the end user will turn a knob inserted in the potentiometer. Detents can be used to add a click feeling to the turning of the potentiometer or to control the position in which the wiper is placed, assuring a particular output value with a narrow tolerance.

Detents can be light or strong, or even a combination of different feelings. They can be evenly distributed along the angle (standard) or tailored to match customers' request. They can also be combined with special tapers: constant value areas, open circuit zone, different slopes, etc. One common example is a potentiometer with detents and matching non-overlapping voltage values in specific angular positions, used to feed in a voltage value to a microprocessor:

Example of 5DT with control of value in each DT.

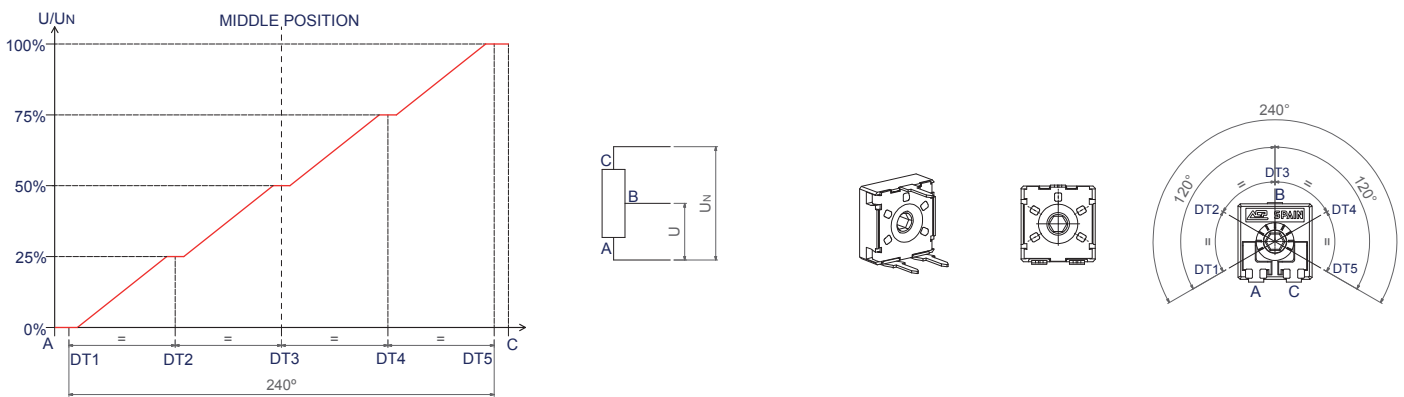

Other examples of potentiometers with detents:

10DT

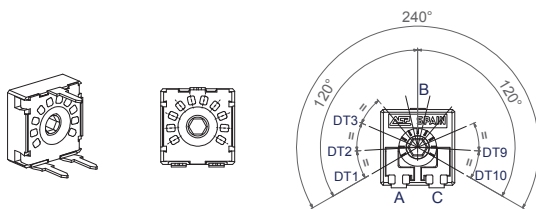

20DT

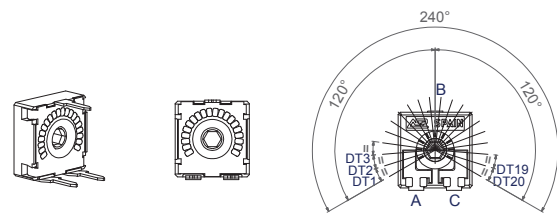

Number of standard detents (evenly distributed) already available.

1 (initial or final), 2 DT (initial and final), 3, 4, 5, 6, 7, 8, 10, 20.

Maximum number of detents for feeling only

20

Maximum number of detents when the voltage value in each detent is controlled and non-overlapping.

10

Our patented design with two wipers has improved the performance of these potentiometers, giving them more stable electrical parameters, improved reliability and Contact Resistance Variation (CRV) as well as narrower tolerances for detent positioning.

For potentiometers with detents, mechanical life is also 1.000 cycles, if no additional cycles are mentioned. Please, indicate the number of cycles needed with LV (number of cycles), for example: LV07, for 7.000 cycles.

When needing a special number of detents or matching taper, a drawing is kindly requested.

Terminals

By default, terminals are always straight, as shown on the “models” section. ACP can provide crimped terminals (with snap in, “SNP” or “SNJ”), to better hold the component to the PCB during the soldering operation.

SNP

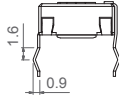

SNJ

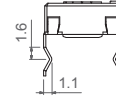

Also, there is an option of having shorter terminal tips:

Standard Terminal

Shorter terminal, for H5 TP25

Shorter terminal, TPXX (under request)

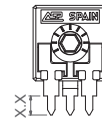
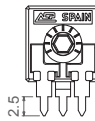
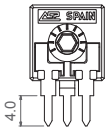

Possibilities for insertion of accessories

Should the shaft need to be positioned differently than shown on the “models” section on this catalogue, a drawing with the exact position is kindly requested.

Shafts

Shafts are available in different colors (color chart in “how to order” section) and with self-extinguishable property, according to UL 94 V-0, under request. ACP can study special shaft designs.

D dimension is the distance from the housing to the top of the shaft, as shown in the different models.

Shaft	9019	9020
D Dimension	17.5	23.5

9019

9020

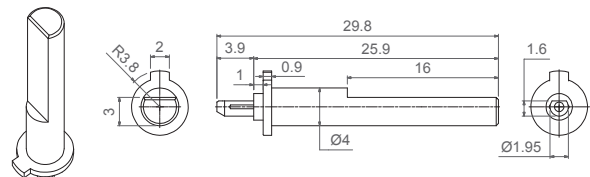
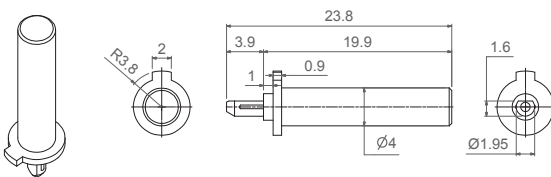

Packaging

Potentiometer model	With shaft or thumbwheel inserted?	Pieces per bigger box (250 x 150 x 70, CG on description)
H2,5 - H3,8 - H5 V7,5 - V10 - VK10 - VR10	9019, 9020	500

Electric Specifications

These are standard features; other specifications and out of range values can be studied on request.

	MCA9 Through-hole	MCE9 Through-hole
Range of resistance values* Lin (A) Log (B) Antilog (C)	$100\Omega \leq R_n \leq 5M\Omega$ $1 K\Omega \leq R_n \leq 2M2\Omega$	$100\Omega \leq R_n \leq 5M\Omega$ $1 K\Omega \leq R_n \leq 2M2\Omega$
Tolerance* Rn < 100Ω: 100Ω ≤ Rn ≤ 100KΩ: 100K < Rn ≤ 1MΩ: 1MΩ < Rn ≤ 5MΩ: Rn > 5MΩ:	+50%, -30% (out of range) ±20% ±20% ±30% +50%, -30% (out of range)	- ±20% ±20% ±30% -
Variation laws	Lin (A), Log (B), Antilog (C). Other tapers available on request	
Residual resistance	Lin (A), Log (B), Antilog (C) ≤ 5*10 ⁻³ *Rn. Minimum value 2Ω	≤2Ω
CRV - Contact Resistance Variation (dynamic)	Lin (A) Electrical Angle 220°±20° ≤ 3%Rn. Other tapers, please inquire	
CRV - Contact Resistance Variation (static)	Lin (A) Electrical Angle 220°±20° ≤ 5%Rn. Other tapers, please inquire	
Maximum power dissipation** Lin (A) Log (B), Antilog (C)	at 50°C 0.15W 0.10W	at 70° C. 0.5W 0.20W
Maximum voltage Lin (A) Log (B), Antilog (C)	150VDC 200VDC	200VDC
Operating temperature	-25°C ... +70°C (+85°C on request)	-40°C ... +90°C (+125°C on request)
Temperature coefficient 100Ω ≤ Rn ≤ 10KΩ 10KΩ < Rn ≤ 5MΩ	+200/ -300 ppm +200/ -500 ppm	±100 ppm ±100 ppm

* Out of range ohm values and tolerances are available on request, please, inquire.

** Dissipation of special tapers will vary, please, inquire.

Mechanical Specifications

	MCA9 Through-hole	MCE9 Through-hole
Resistive element	Carbon technology	Cermet
Angle of rotation (mechanical)	240° ± 5°	
Angle of rotation (electrical)	220° ± 20°	
Wiper standard delivery position	50% ± 15°	
Max. stop torque	5 Ncm	
Max. push/pull on rotor	40 N	
Wiper torque*	<2 Ncm Potentiometers with detents: <2.5 Ncm	
Mechanical life	1.000 cycles (many more available on request, please, inquire)	

* Stronger or softer torque feeling is available on request.

Test results

The following typical test results are given at 23°C ±2°C and 50% ±25% RH.

	MCA9 Through-hole		MCE9 Through-hole	
	Test conditions	Typical variation of nominal resistance	Test conditions	Typical variation of nominal resistance
Damp heat	500 h. at 40°C and 95% RH	+5%, -2%	500 h. at 40°C and 95% RH	±2%
Thermal cycles	16 h at 85°C, plus 2 h at -25°C	±2.5%	16 h at 90°C, plus 2 h at -40°C	±2%
Load life	1.000 h. at 50°C	+0%; -6%	1.000 h. at 70°C	±2%
Mechanical life	1.000 cycles at 10 c.p.m. and at 23°C ± 2°C	±3%	1.000 cycles at 10 c.p.m. and at 23°C ± 2°C	±3%
Storage (3 years)	3 years at 23°C ± 2°C	±3%	3 years at 23°C ± 2°C	±1%

MCA9 Through-hole

MCE9 Through-hole

Power derating curve:

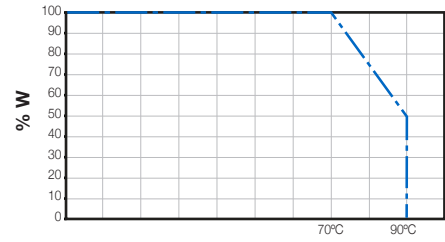
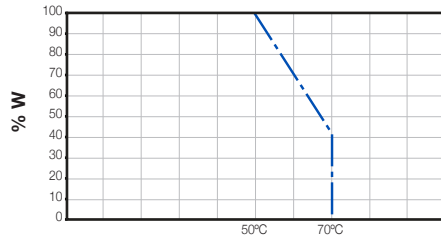

For temperatures out of range

The normal operation temperature for a carbon ACP potentiometer is -25°C to +70°C. When the temperature goes up to 85°C, the following variations should be observed:

Load life	1.000 h. at 50°C	+0%; -6%	1.000 h. at 85°C	+0%; -15%
-----------	------------------	----------	------------------	-----------

The power derating curve to consider is:

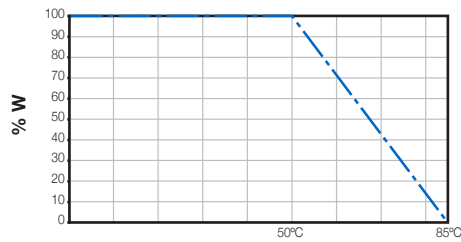

Representation of the typical variation of nominal resistance (with 95% confidence) throughout the ohm value range:

MCA9 Through-hole

MCE9 Through-hole

Damp heat

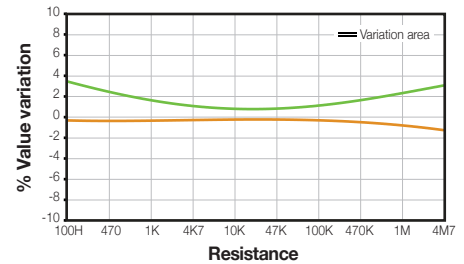
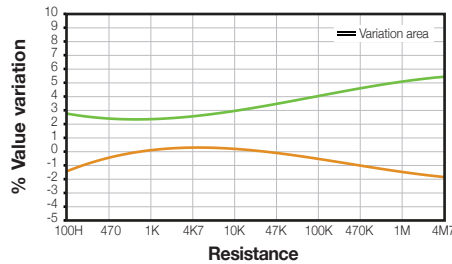

Temperature Coefficient

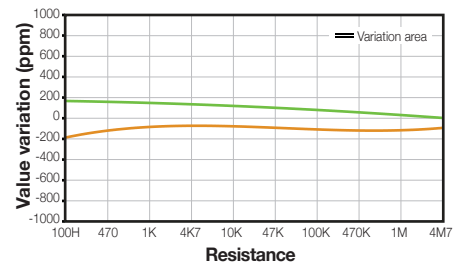
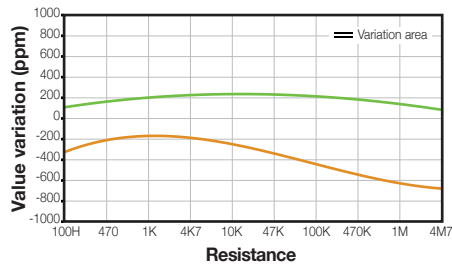

Load life

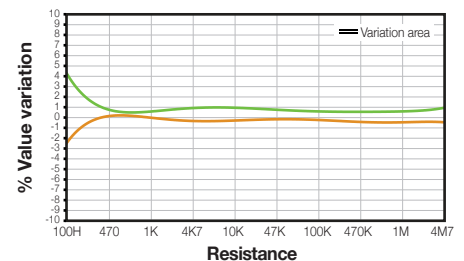
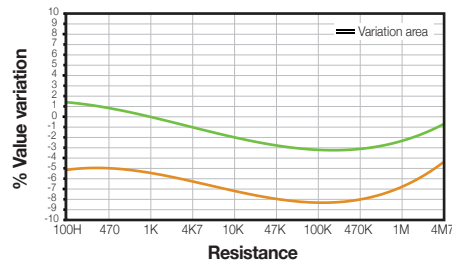

Mechanical life

