

RS14

Rotary Sensor

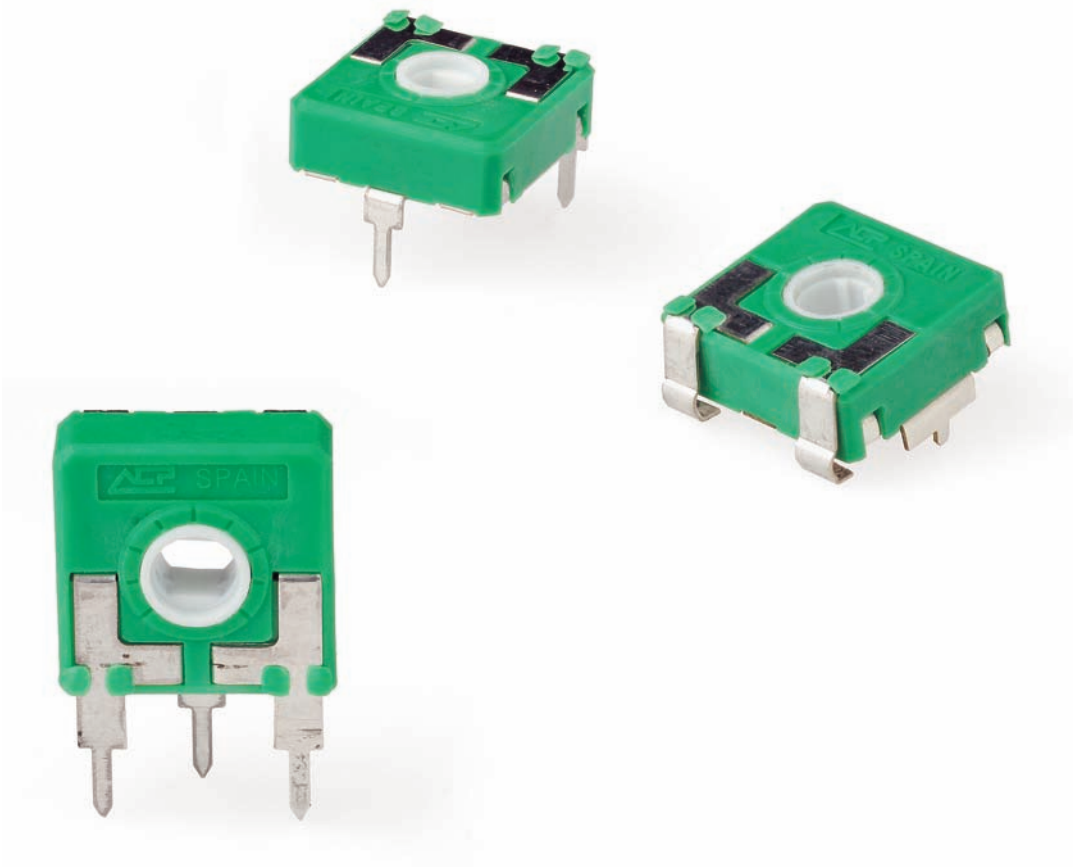

RS14

14mm Rotary Sensor with up to 1.000.000 cycles of mechanical life on its standard configuration, making it particularly appropriate for control applications.

RS14 has plastic housing and Ingress Protection rating type IP 54 (high level of protection against dust and also against water splashing), according to IEC 60529. Plastic materials can be self-extinguishable according to UL 94 V-0 under request.

Through-hole and SMD configurations are available. Terminals and collector are manufactured in tinned brass, although versions with steel terminals are also available under request. Terminals for through-hole models can be provided straight or crimped, which helps hold the component to the PCB during soldering.

Standard taper is linear, with linearity of $\pm 3\%$. ACP can study other special tapers (even cut tracks, step curves with areas of constant value, etc), as well as more strict linearity.

Thumbwheels and shafts can be provided either separately or already inserted in the sensor. Our RS14 can be manufactured in a wide range of possibilities regarding: resistance value, tolerance, tapers, pitch, positioning of the wiper, housing and rotor color.

Applications

- Household appliances: temperature control, position sensor.
- Automotive: position adjustment and sensing.
- Industrial controls.

RS14 HOW TO ORDER

EXAMPLE: **RS14TV15-10KA3030 WT-14008-NE-V0**

Standard features								Extra features							Assembled accessory			
Series	Rotor	Model	Packg.	Ohm value	Taper	Tol.	Life	Track	Detents	Snap in	Housing	Rotor	Wiper	Lin.	Assembly	Ref #	Color	Flam.
1	2	3	4	5	6	7	8	9	10	11	12	13	14	15	16			
RS14	T	V15		- 10K	A	3030									WT	-14008	-NE	-V0

Standard configuration:	RS14 Through-hole	RS14 SMD
Dimensions:	14mm	
Protection:	IP 54 (dust-proof) On request: Self-extinguishable, to meet UL 94 V-0	
Substrate:	Carbon technology	Carbon technology, special for high temperature
Color:	Green housing + white rotor	Green housing + grey rotor
Packaging:	Bulk	
Wiper position:	at 50% ±15°	
Terminals:	Straight, without crimping.	
Marking:	Resistive value marked on housing. Others on request.	

Customized products: A drawing is requested when ordering a customized product. Series, rotor, model and total resistive value are indicated before the code that includes all special specifications. Example: RS14TV15-10K CODE C00111.

1 - Series

■ RS14

2 - Rotors

F _____ N _____ T _____ Z _____

3 - Model and pitch

H0 H0C H2,5 H4 H5 HA5 HL5 V12,5 VA12,5 VL12,5
 VR12,5 V15 VJ15 (V15) ... CFF V17,5 VD7,5 VD11 VSMD VSMD ... CY
 HSMD (Under request, not readily available)

4 - Packaging

	Trough-hole	SMD models
Bulk	(blank)... ⁽¹⁾	(blank)... ⁽¹⁾
T&R (Tape and 13" reel)	(N.A.) ⁽²⁾	T&R
T&R (Tape and 15" reel)	(N.A.) ⁽²⁾	T&R15

(1) If blank, bulk packaging is implied. (2) N.A., Not Applicable: Tape and Reel packaging is only available for SMD terminals.

5 - Resistance value

10K

The RS14 has 10K, linear taper and ±30% by default. Other resistive values, tolerances and tapers (log, antilog, cut tracks, constant value areas, etc.) can be studied on request. Please, enclose a drawing when ordering special tapers.

6 - Resistance law / taper

Lin - Linear	A
- Special tapers have codes assigned:	CODE YXXXXX

7 - Tolerance

±30%

3030

8 - Operating Life (Cycles)

Standard (1.000 cycles)	(leave blank)
Long life: LV + number of cycles. i.e: LV100 for 100.000 cycles, LV150, LV1M	LVXXX: ex: LV100

9 - Cut Track - Open circuit.

Open circuit at beginning of track, fully CCW	PCI
Open circuit at end of track, fully CW	PCF

10 - Detents (DT)

Not applicable for RS14

11 - Terminals

SNAP IN P	SNP
SNAP IN J	SNJ
Shorter tip of terminal, TPXX, where XX is tip length (under request)	TPXX, ex: TP30
Steel Terminals	SH

12 - Housing

Color: For colors other than standard: -See color chart below- CJ-color, ex., red: CJ-RO

13 - Rotor

Color: For colors other than standard: -See color chart below- RT-color; ex., blue: RT-AZ

* Self-extinguishable property, V0, for housing and rotor:

By default, carbon is non self-extinguishable. Self-extinguishable property can be added. V0 means housing and rotor are V0. If only the housing needs to be V0, then CJ-V0. If only rotor: RT-V0

14 - Wiper

Wiper position (Standard: 50% ± 15°) (leave blank)

Initial or CCW	PI
Final or CW	PF
Others: following clock positions; at 3 hours: P3H	PXH, ex: P3H

Wiper torque (Standard: <1.5Ncm) (leave blank)

Stronger or softer torque feeling is available on request.

15 - Linearity

Standard linearity 3%	(leave blank)
Independent linearity controlled & below x%, for example, 2%: LN2%	LNx%; ex: LN2%
Absolute linearity controlled & below x%	LAX%

Other features could be available on request, please, ask.

16 - Potentiometers with assembled accessories

Assembled from terminal side	WT
Assembled from collector side	WTI
Accessory Reference	-XXXXX Example: 14117
See list of shafts and thumbwheels available	
Color of shaft or thumbwheel	-YY Example, white: BA
Non self-extinguishable. Self-extinguishable according to standard UL 94 (-V0 in box 17 modifies only the accessory, please, note.)	(leave blank) -V0
For ordering spare accessories: Accessory reference - color- flammability. Ex. 14117-AZ-V0 is a blue self-extinguishable 14117 thumbwheel	XXXX-YY-V0

Color chart for rotor, housing and accessories

Black ⁽¹⁾	White	Neutral	Transp.	Red	Green	Yellow	Blue	Grey	Brown
NE	BA	IN	TA	RO	VE	AM	AZ	GS	MR

(1) black is not an option for housings.

Rotors

T is the standard rotor for RS14. Rotors are drawn in their standard positioning, 50% of rotation. Alternative delivery positioning can be requested. Accessories in this catalogue are designed for N, Z and T rotors, unless otherwise stated. Other rotor styles, on request.

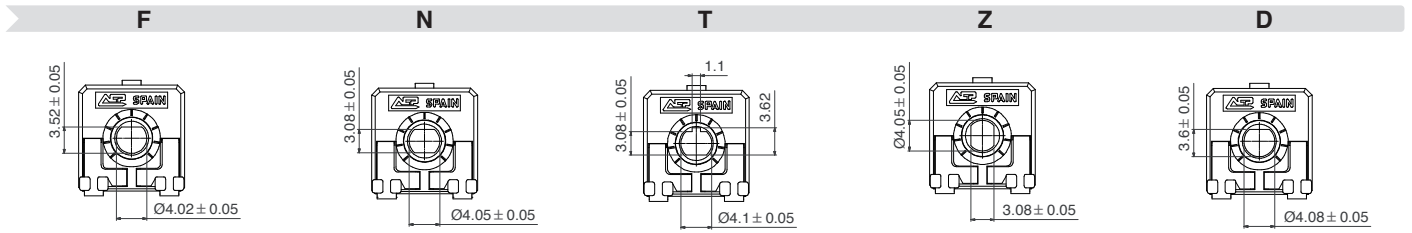

Standard color for F rotor is red

Models

All models shown here have the most common rotor for RS14, the T rotor.

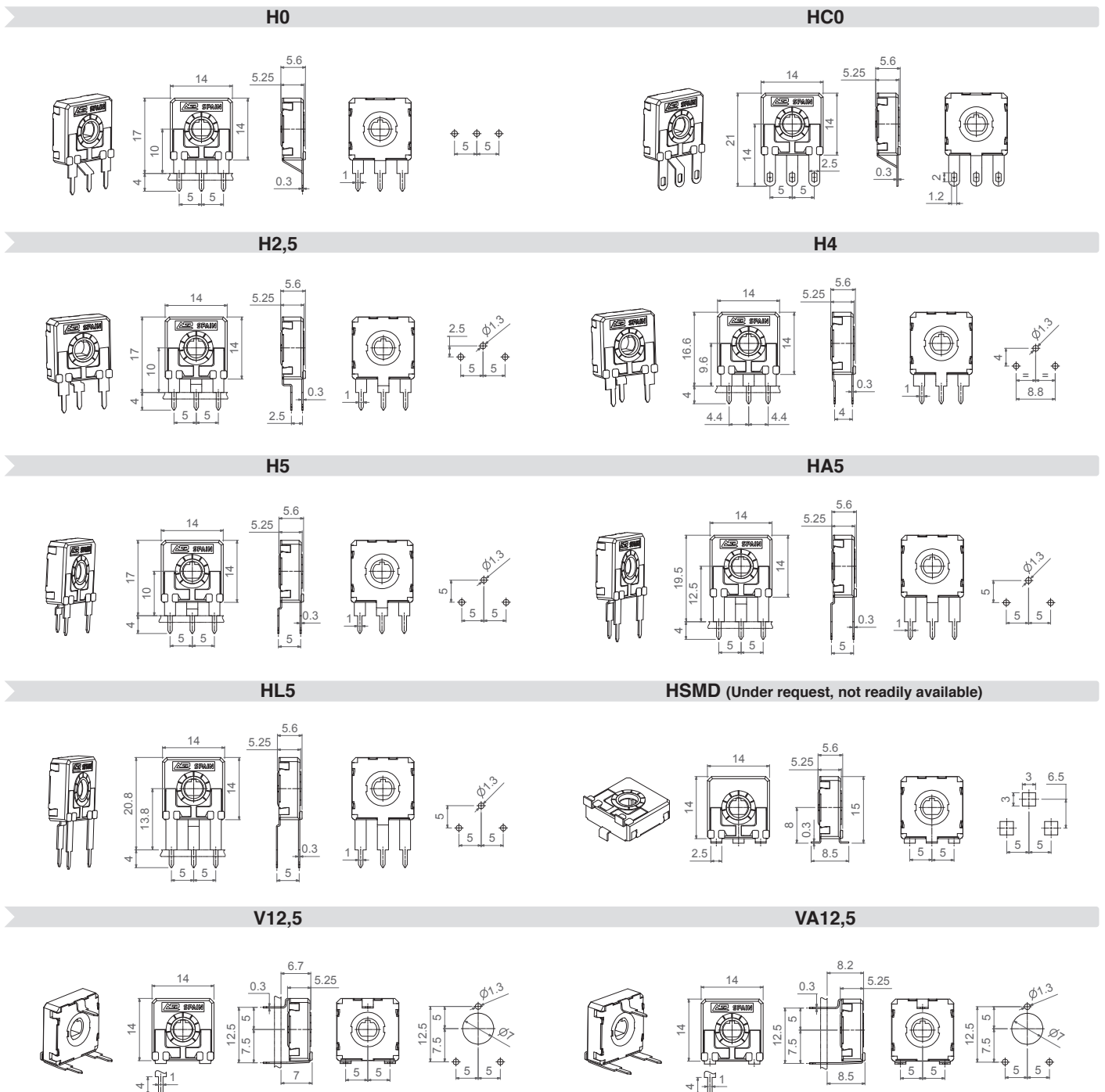

RS14

VL12,5

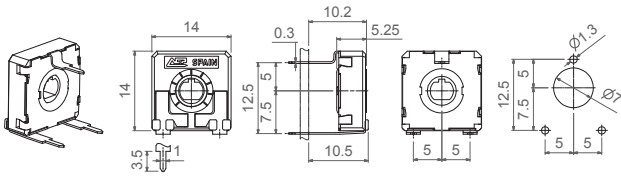

VR12,5

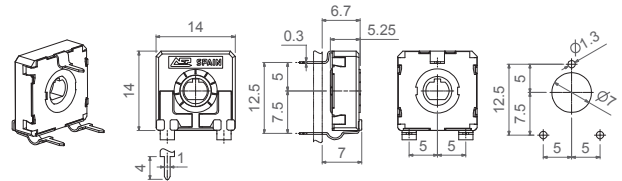

V15

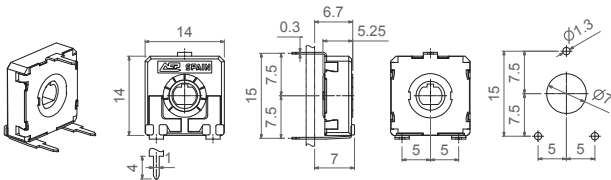

VJ15

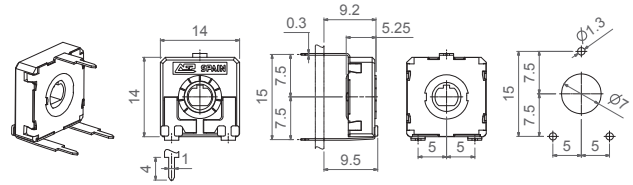

V15...CFF

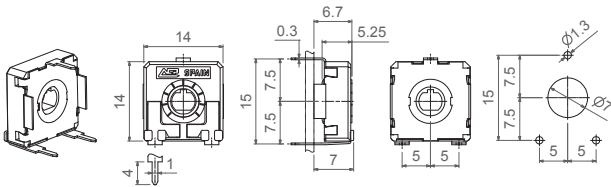

V17,5

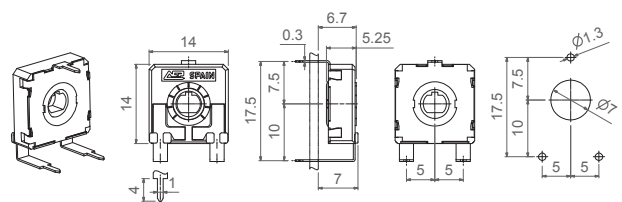

VD7,5

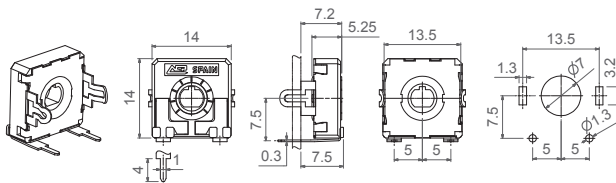

VD11

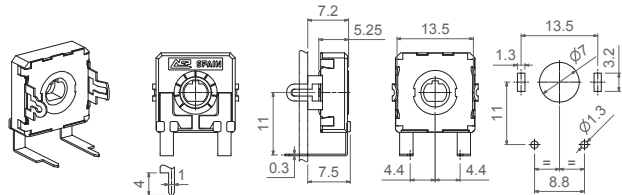

VSMD

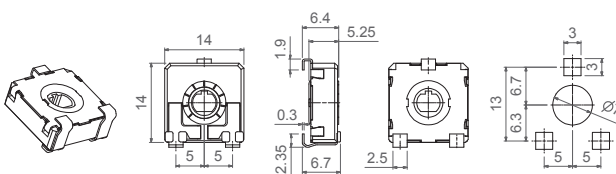

VSMD...CY

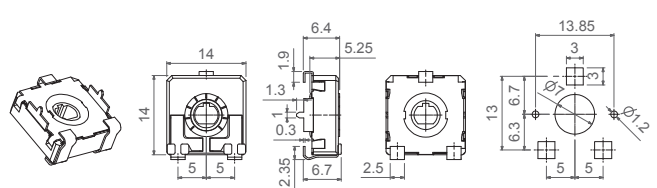

Tapers

The standard taper is linear (A) and the standard ohm value is 10K, since a RS14 will normally be used as a voltage divider. For other tapers, please, inquire.

Voltage Divider

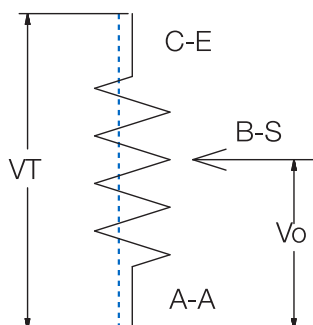

Potentiometers with cut track

The cut track is an area with very high resistive value, resulting in an open circuit. It is widely used in lighting applications. Mechanical life available with cut track needs to be confirmed case by case.
 PCI = Cut at initial position, when the potentiometer is turned fully counter clockwise.
 PCF = Cut at final position, when the potentiometer is turned fully clockwise.
 Other positions are available on request.

PCI

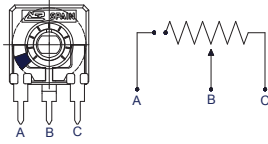

PCF

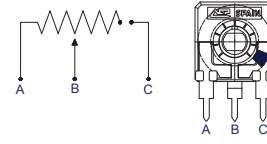

Terminals

By default, terminals are always straight, as shown on the “models” section. ACP can provide crimped terminals (with snap in, “SNP” or “SNR”) to better hold the component to the PCB during the soldering operation.

SNP

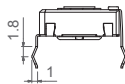

SNR

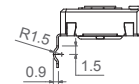

Also, there is an option of having shorter terminal tips.

Standard Terminal

Shorter terminal, for V12,5 TP30

Shorter terminal, TPXX (under request)

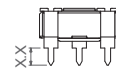
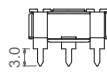
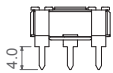

Possibilities for insertion of accessories

Accessories can be mounted on potentiometers through either the front side (WT) or the collector side (WTI). For the specific angular position of shafts with planes, a drawing with the exact position is requested.

WT Front side

WTI Collector side

WT Front side

WTI Collector side

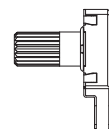
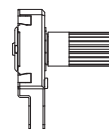
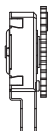

Shafts

Shafts are available in different colors (color chart in “how to order” section) and with self-extinguishable property, according to UL 94 V-0, under request. ACP can study special shaft designs.

Shafts can be sold separately or delivered already mounted on the potentiometer at ACP.

When a shaft is mounted on a potentiometer, the distance from the top of the potentiometer to the top of the shaft is marked with “L” in the table below, as shown in the drawings:

H potentiometer + shaft

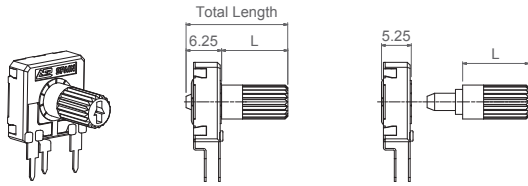

V potentiometer + shaft

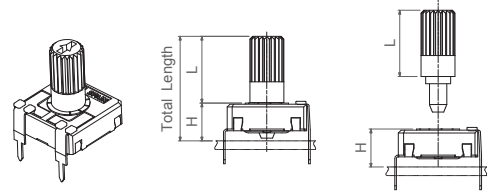

Shaft	14042	14065 (For E rotor)	14117	14056	14081	14187	14251	14067	14008	14015	14066	14084	14250	14072	14073
L Dimension	7.05	11.50	11.70	12.25	18.25	18.75	18.75	27.75	23.25	23.25	23.50	23.50	25.00	31.75	38.50

14008

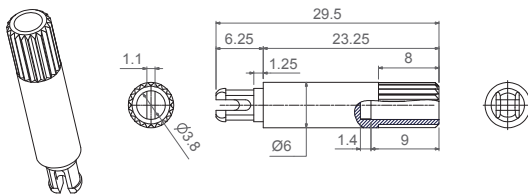

14015

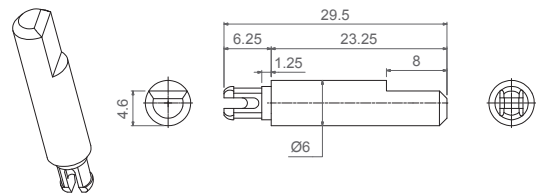

14042

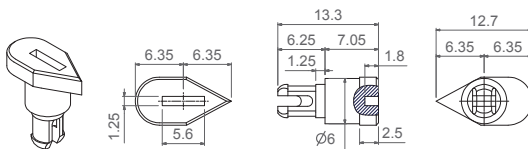

14056

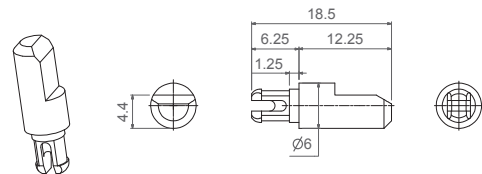

14065 (Designed for E rotor)

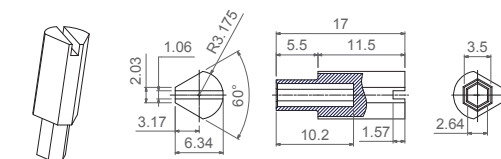

14066

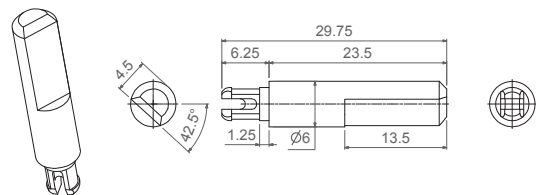

14067

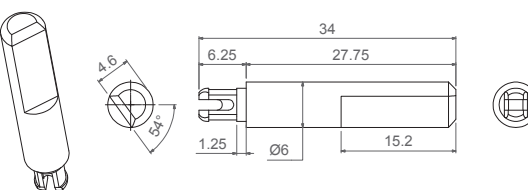

14072

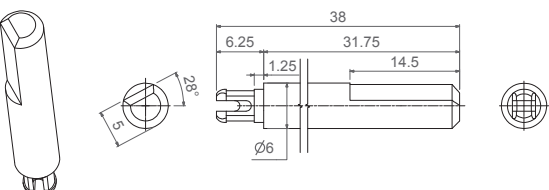

14073

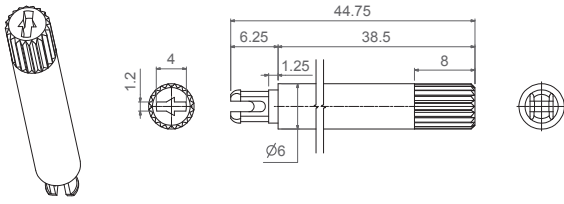

14081

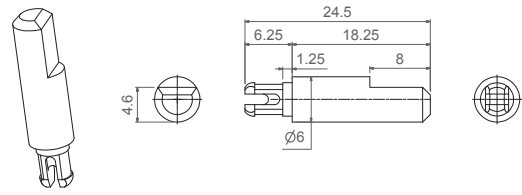

14084

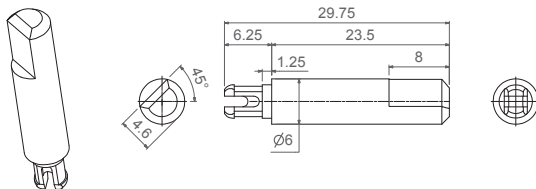

14117

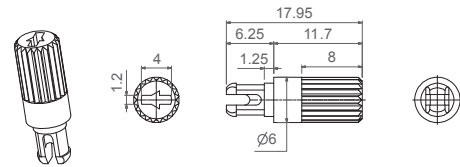

14187

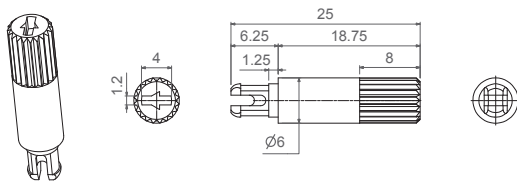

14250

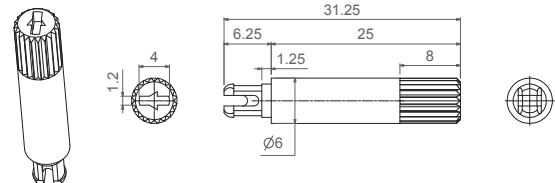

14251

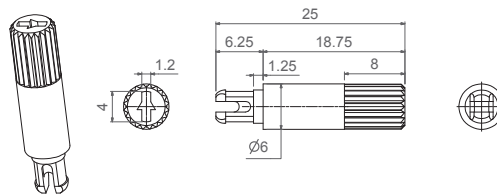

Thumbwheel

Thumbwheels are available in different colors (color chart in "how to order" section) and with self-extinguishable property according to UL 94 V-0, under request. Thumbwheels can be mounted on the potentiometers at ACP or sold separately. ACP can study special thumbwheel designs.

14003

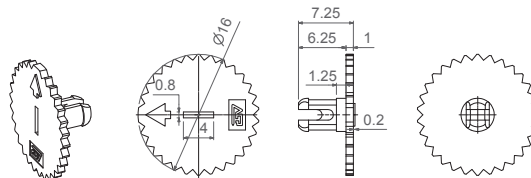

Bulk packaging:

RS14 model	With shaft or thumbwheel inserted?	Pieces per small box (150 x 100 x 70)	Pieces per bigger box (250 x 150 x 70, CG on description)
H2,5 - H4 - H5- HA5- HL5- H0 HCO - V12,5 - V15 - VA12,5 VL12,5 - VJ15 - V17,5* VD11* - VD7,5* - VR12,5	None, only potentiometers.	200 150 for models with*	700 600 for VJ15 - V17,5 - VD7,5 500 for VD11
	14003, 14117, 14042, 14056, 14065	100	400 350 for models with*
	14008, 14015, 14066, 14067, 14072, 14073, 14081, 14084, 14187, 14250.	75	To be determined.

For models with * and an inserted accessory, please, inquire about the quantity per box in that case.

Tape & Reel packaging:

	With thumbwheel inserted?	13" Reel (Standard), with 24mm width tape	15" Reel, with 24mm width tape
VSMD	None, only potentiometers.	500 pcs per reel, 16mm step between cavities.	800 pcs per reel, 16mm step between cavities.
	14003	450 pcs per reel, 16mm step between cavities.	To be determined.
VSMD... CY	None, only potentiometers.	350 pcs per reel, 20mm step between cavities.	500 pcs per reel, 20mm step between cavities.
	14003	To be determined.	To be determined.

The 13" reel is the standard. For the 15" reel, T&R15 is added to the description.

VSMD-T&R

VSMD-T&R...WT-14003

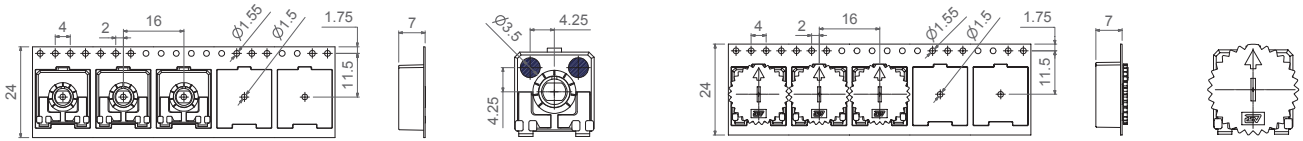

VSMD-T&R ... CY

VSMD-T&R...CY WT-14003

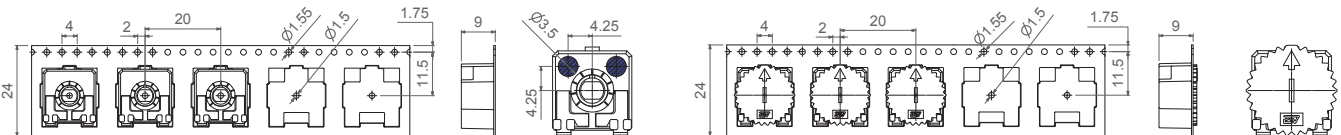

13" Reel

15" Reel



Electric Specifications

These are standard features; other specifications and out of range values can be studied on request.

	RS14 Through-hole	RS14 SMD
Range of resistance values* Lin (A)	Standard value is 10K, as voltage divider use is supposed	
Tolerance*	30%	
Variation laws	Lin (A). Other tapers available on request	
Residual resistance	Minimum value 2Ω	
CRV - Contact Resistance Variation (dynamic)	Lin (A) Electrical Angle 245°±20° ≤ 3%Rn. Other tapers, please inquire	
CRV - Contact Resistance Variation (static)	Lin (A) Electrical Angle 245°±20° ≤ 5%Rn. Other tapers, please inquire	
Maximum power dissipation** Lin (A)	at 50°C, 0.15W	
Maximum voltage Lin (A)	250VDC	
Operating temperature	-25°C ... +85°C	
Linearity	3%	
Temperature coefficient 100Ω ≤ Rn ≤ 10KΩ 10KΩ < Rn ≤ 5MΩ	+200/ -300 ppm +200/ -500 ppm	+200/ -500 ppm +200/ -1000 ppm

* Out of range ohm values and tolerances are available on request, please, inquire.

** Dissipation of special tapers will vary, please, inquire.

Mechanical Specifications

RS14 Through-hole and SMD

Resistive element	Carbon technology
Angle of rotation (mechanical)	265° ± 5°
Angle of rotation (electrical)	245° ± 20°
Wiper standard delivery position	50% ± 15°
Max. stop torque	10 Ncm
Max. push/pull on rotor	50 N
Wiper torque*	<1.5 Ncm
Mechanical life	Up to 1.000.000 cycles (please, specify the cycles needed).

* Stronger or softer torque feeling is available on request.

Test results

The following typical test results (with 95% confidence) are given at 23°C ±2°C and 50% ±25% RH. Maximum linearity after mechanical tests: 4%.

RS14 Through-hole and SMD

	Test conditions	Typical variation of Rn
Damp heat	500 h. at 40°C and 95% RH	±20%
Temperature Coefficient	16 h at 85°C, plus 2 h at -25°C	±20%
Load life	1.000 h. at 50°C	±20%
Mechanical life	150.000 cycles at 10 c.p.m. and at 23°C ± 2°C	±20%
Storage (3 years)	3 years at 23°C ± 2°C	±3%

Power derating curve:

